



LISTINO CONTRACT

CONTRACT
PRICE LIST

2022

V1 | 02.22

Urbo è una storia che continua da 12 anni, il racconto di un'azienda Made in Italy universalmente riconosciuta per qualità e design. Ancora oggi, **Urbo** si distingue per il know-how nella lavorazione e nella durezza del metallo, per la passione e l'entusiasmo delle persone, patrimonio inestimabile dell'azienda. Il sapiente connubio tra innovazione tecnologica, saper fare artigiano e la stretta collaborazione con designer di fama mondiale, rende i prodotti **Urbo** delle soluzioni d'arredo perfette per ogni stile e ambiente.

URBO E L'AMBIENTE

L'attenzione che **Urbo** pone verso l'ambiente copre l'intero ciclo di vita del prodotto, dall'impiego di materiali riciclabili al 100%, come l'acciaio e l'alluminio, al riciclo ed alla minimizzazione degli scarti. Tutto il legno delle collezioni è teak FSC® 100%, ovvero proveniente da foreste gestite in maniera responsabile secondo rigorosi standard ambientali, sociali ed economici. L'azienda è anche impegnata nella riduzione costante dell'utilizzo della plastica negli imballi, composti da cartone riciclabile e dalle dimensioni sempre più contenute. La compatibilità ambientale di tutta la gamma **Urbo** è garantita da processi eseguiti all'interno dei propri stabilimenti ed è, inoltre, in sviluppo un impianto fotovoltaico da 1 megawatt entro il 2023, con lo scopo di alimentare l'azienda con energia Green. Urbo nei suoi 12 anni di evoluzione, rinnova sempre l'entusiasmo per l'innovazione e il rispetto per l'ecosistema. La lunga vita utile del prodotto riduce in maniera significativa l'inquinamento e l'impatto ambientale.

Urbo is a story that has been going on for 12 years, the tale of a Made in Italy company universally recognized for quality and design. Even today, **Urbo** stands out for its know-how in the processing and durability of metal, for the passion and enthusiasm of the people, an invaluable asset of the company. The skilful connection with technological innovation, craftsmanship and close collaboration with world-renowned designers, makes **Urbo** products the perfect furnishing solutions for every style and environment.

URBO AND THE ENVIRONMENT

The attention that **Urbo** pays to the environment covers the entire life cycle of the product, from the use of 100% recyclable materials, such as steel and aluminum, to recycling and waste minimization. The collections containing the wood are made of 100% FSC® teak, which means that it comes from forests managed in a responsible manner according to strict environmental, social and economic standards. The environmental compatibility of the entire **Urbo** range is guaranteed by processes carried out within its factories and a 1 megawatt photovoltaic system is also under development by 2023, with the aim of powering the company with Green energy. In its 12 years of evolution, **Urbo** always renews the enthusiasm for innovation and respect for the ecosystem. The long useful life of the product significantly reduces pollution and environmental impact.



BASI	7
Supports	
TAVOLI	19
Tables	
SEDUTE	27
Seats	
COLLEZIONI	45
Collections	
LAMPADE	51
Lights	
MATERIALI E FINITURE	57
Materials & Finishes	

BASI

SUPPORTS



ELBA



Base in metallo a tondini diametro 20 mm, verniciatura in cataforesi e finitura per esterni.
Metal support with 20 mm diameter rods, cathaphoresis painting and finish for outdoor.

Finiture standard
Standard finishes



Finiture metallo
Metal coatings



Oggetto Item	Caratteristiche Tecniche (cm) Technical features (cm)			Prezzo Price	Imballo pz Packing pz		
	Piastra (a) Support	Base (b) Base	Altezza (h) Height		Finitura standard Standard Coating	Finitura Metallo Metal Coating	Volume mc Volume mc
ELBA 45	25	Ø 45	108 74				
ELBA 50	25	Ø 50	108 74				
ELBA 60	25	Ø 60	108 74				

*: piano non incluso / top not included

***: inclusi feltrini a terra, imballo industriale con sacco di protezione, viteria e istruzioni montaggio.
including floor felt pads, industrial packaging with protective bag, screws and assembly instructions.

Dimensione max piano
Max top dimension

Diametro Diameter	Lato Side
Elba 45 cm	70
Elba 50 cm	90
Elba 60 cm	120

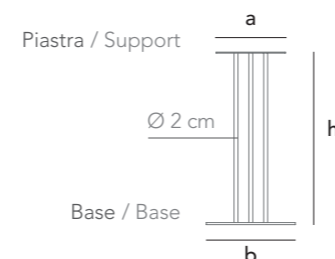
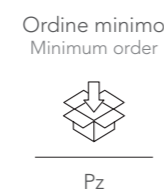

ISCHIA



Base in metallo, mono gamba a tubo quadro, verniciatura in cataforesi e finitura per esterni.
Metal support, single squared leg, cathaphoresis painting and finish for outdoor.

Finiture standard
Standard finishes



Finiture metallo
Metal coatings

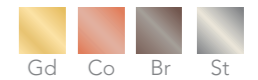

Oggetto Item	Caratteristiche Tecniche (cm) Technical features (cm)			Prezzo Price	Imballo pz Packing pz		
	Piastra (a) Support	Base (b) Base	Altezza (h) Height		Finitura standard Standard Coating	Finitura Metallo Metal Coating	Volume mc Volume mc
ISCHIA 39	25	39	108 74				
ISCHIA 47	25	47	108 74				
ISCHIA 60	25	60	108 74				
ISCHIA 75	25	75	108 74				

*: piano non incluso / top not included

***: inclusi feltrini a terra, imballo industriale con sacco di protezione, viteria e istruzioni montaggio.
including floor felt pads, industrial packaging with protective bag, screws and assembly instructions.

Dimensione max piano leggero
Max light top dimension

Diametro Diameter	Lato Side
Ischia 39 cm	70
Ischia 47 cm	85
Ischia 60 cm	120
Ischia 75 cm	140

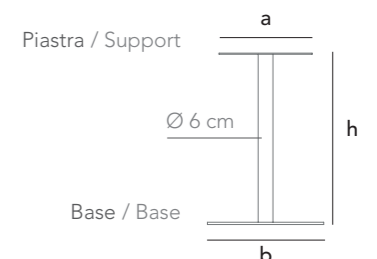
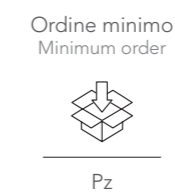

ISCHIA R

Base regolabile
Adjustable support



Base in metallo regolabile, mono gamba a tubo quadro, verniciatura in cataforesi e finitura per esterni.
Metal adjustable support, single squared leg, cataphoresis painting and finish for outdoor.

Finiture standard
Standard finishes



Finiture metallo
Metal coatings



Oggetto Item	Caratteristiche Tecniche (cm) Technical features (cm)			Prezzo Price	Imballo pz Packing pz		
	Piastra (a) Support	Base (b) Base	Altezza (h) Height		Finitura standard Standard Coating	Finitura Metallo Metal Coating	Volume mc Volume mc
ISCHIA 39R	25	39	68/108				
ISCHIA 47R	25	47	68/108				
ISCHIA 60R	25	60	68/108				

*: piano non incluso / top not included

***: inclusi feltrini a terra, imballo industriale con sacco di protezione, viteria e istruzioni montaggio.
including floor felt pads, industrial packaging with protective bag, screws and assembly instructions.

Dimensione max piano
Max top dimension

Diametro Diameter	Lato Side
Elba 45 cm	70
Elba 50 cm	90
Elba 60 cm	120

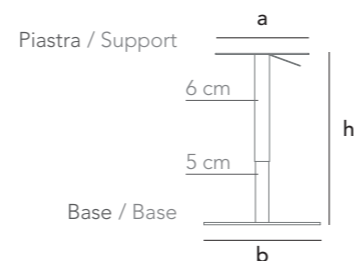
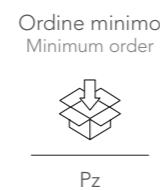

PONZA

Base
Support



URBO consiglia l'abbinamento con
URBO suggests pairing with



Sedute serie Tondina
Tondina serie seats



Sedute serie Offset
Offset serie seats

Base in metallo, tondini diametro 11 mm, verniciatura in cataforesi e finitura per esterni.
Metal support, 11 mm diameter rods, cataphoresis paint and finish for outdoor.

Finiture standard
Standard finishes



Finiture metallo
Metal coatings



Oggetto Item	Caratteristiche Tecniche (cm) Technical features (cm)			Prezzo Price	Imballo pz Packing pz		
	Piastra (a) Support	Base (b) Base	Altezza (h) Height		Finitura standard Standard Coating	Finitura Metallo Metal Coating	Volume mc Volume mc
PONZA 50	40	Ø 50	108 74				
PONZA 60	50	Ø 60	108 74				

*: piano non incluso / top not included

***: inclusi feltrini a terra, imballo industriale con sacco di protezione, viteria e istruzioni montaggio.
including floor felt pads, industrial packaging with protective bag, screws and assembly instructions.

Dimensione max piano
Max top dimension

Diametro Diameter	Lato Side
Ponza 50 cm	90
Ponza 60 cm	120

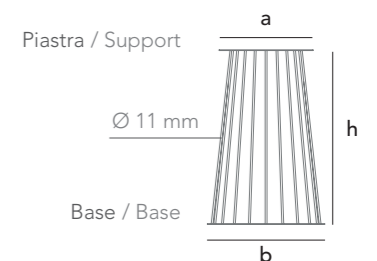
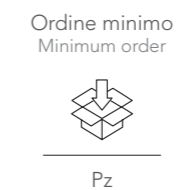

SALINA



Base in metallo, tubolari diametro 40 mm, verniciatura in cataforesi e finitura per esterni.
Metal support, tubulars diameter 40 mm, cataphoresis paint and finish for outdoor.

Finiture standard
Standard finishes



Finiture metallo
Metal coatings



Oggetto Item	Caratteristiche Tecniche (cm) Technical features (cm)			Prezzo Price	Imballo pz Packing pz		
	Piastra (a) Support	Base (b) Base	Altezza (h) Height		Finitura standard Standard Coating	Finitura Metallo Metal Coating	Volume mc Volume mc
SALINA 45	25	Ø 45	108 74				
SALINA 50	30	Ø 50	108 74				
SALINA 60	40	Ø 60	108 74				

*: piano non incluso / top not included

***: inclusi feltrini a terra, imballo industriale con sacco di protezione, viteria e istruzioni montaggio.
including floor felt pads, industrial packaging with protective bag, screws and assembly instructions.

Dimensione max piano
Max top dimension

Diametro Diameter	Lato Side
Salina 45 cm	70
Salina 50 cm	90
Salina 60 cm	120

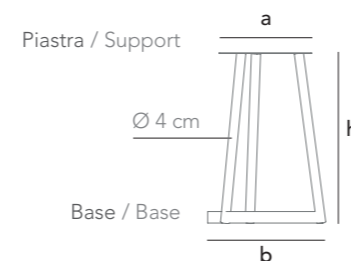
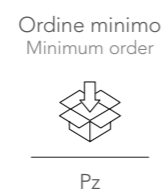

STAND FOUR



Base in metallo a quattro gambe, verniciatura in cataforesi e finitura per esterni.
Metal support with four legs, cataphoresis paint and finish for outdoor.

Finiture standard
Standard finishes



Finiture metallo
Metal coatings



Oggetto Item	Caratteristiche Tecniche (cm) Technical features (cm)		Prezzo Price	Imballo pz Packing pz		
	Piastra (a) Support	Altezza (h) Height		Finitura standard Standard Coating	Finitura metal Metal Coating	Volume mc Volume mc
STAND FOUR 70	25	75				
STAND FOUR 80	35	75				

*: piano non incluso / top not included

***: inclusi feltrini a terra, imballo industriale con sacco di protezione, viteria e istruzioni montaggio.
including floor felt pads, industrial packaging with protective bag, screws and assembly instructions.

Dimensione max piano
Max top dimension

Diametro Diameter	Lato Side
Stand 70 cm	70
Stand 80 cm	80

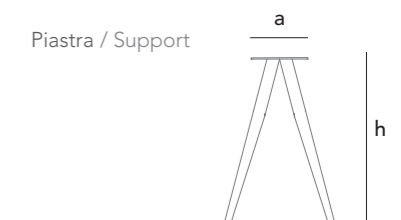
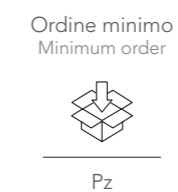

STAND THREE



Base in metallo a tre gambe, verniciatura in cataforesi e finitura per esterni.
Metal support with three legs, cataphoresis paint and finish for outdoor.

Finiture standard
Standard finishes



Finiture metallo
Metal coatings



Oggetto Item	Caratteristiche Tecniche (cm) Technical features (cm)		Prezzo Price		Imballo pz Packing pz	
	Piastra (a) Support	Altezza (h) Height	Finitura standard Standard Coating	Finitura metal Metal Coating	Volume mc Volume mc	Peso kg Weight kg
STAND THREE 70	25	75				
STAND THREE 80	35	75				

*: piano non incluso / top not included

** : inclusi feltrini a terra, imballo industriale con sacco di protezione, viteria e istruzioni montaggio.
including floor felt pads, industrial packaging with protective bag, screws and assembly instructions.

Dimensione max piano Max top dimension	
Diametro Diameter	Lato Side
Stand 70 cm	Stand 80 cm
70	80

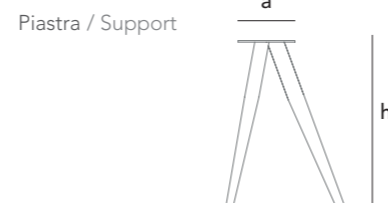
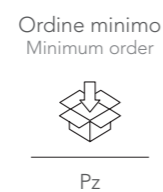

STROMBOLI



Base in metallo, mono gamba a tubo tondo, verniciatura in cataforesi e finitura per esterni.
Metal support, single round leg, cataphoresis painting and finish for outdoor.

Finiture standard
Standard finishes



Finiture metallo
Metal coatings

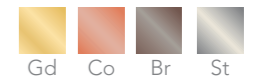

Oggetto Item	Caratteristiche Tecniche (cm) Technical features (cm)			Prezzo Price		Imballo pz Packing pz	
	Piastra (a) Support	Base (b) Base	Altezza (h) Height	Finitura standard Standard Coating	Finitura Metallo Metal Coating	Volume mc Volume mc	Peso kg Weight kg
STROMBOLI 39	25	Ø 39	108 74				
STROMBOLI 47	25	Ø 47	108 74				
STROMBOLI 60	25	Ø 60	108 74				
STROMBOLI 75	25	Ø 75	108 74				

*: piano non incluso / top not included

** : inclusi feltrini a terra, imballo industriale con sacco di protezione, viteria e istruzioni montaggio.
including floor felt pads, industrial packaging with protective bag, screws and assembly instructions.

Dimensione max piano leggero Max light top dimension			
Diametro Diameter	Lato Side		
vers. 39 cm	vers. 47 cm	vers. 60 cm	vers. 75 cm
70	85	120	140

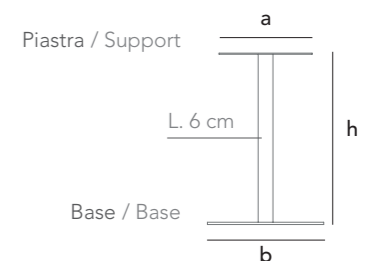
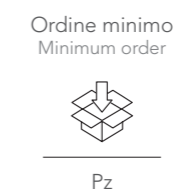

TAVOLI

TABLES

design
Lana+Savettiere Architetti



BRIGITTE 110

BRIGITTE 70

design
Lana+Savettiere Architetti



AUDREY 60

AUDREY 45

AUDREY 80

ARDENNE h. 110

ARDENNE h. 76

ARDENNE

Tavolo
Table



Impilabile
Stackable



Tavolo in metallo a 4 gambe tubolari, lato 4 cm, con tappi. Finitura goffrata.
Metal table with 4 tubular legs, side 4 cm, with caps. Embossed finish.

Finiture standard
Standard finishes



Oggetto Item	Caratteristiche Tecniche (cm) Technical features (cm)			Prezzo Price	Imballo pz Packing pz	
	Altezza (h) Height	Lato 1 Side 1	Lato 2 Side 2		Finitura standard Standard Coating	Volume mc Volume mc
ARDENNE 45	45	60	60			
		70	70			
		80	80			
ARDENNE 76	76	70	70			
		80	80			
		90	90			
ARDENNE 110	110	70	70			
		80	80			
		90	90			

** : inclusi tappi, puntali a fungo, protezioni su gambe e separatori in cartone.
including caps, push-in feet, leg guards and cardboard separators.

Ordine minimo
Minimum order



Pz

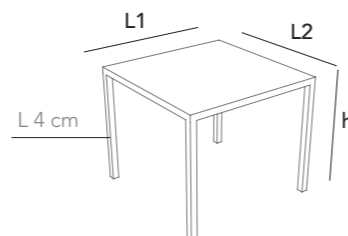

AUDREY

design: Lana+Savettiere Architetti

Tavolo
Table



Tavolo in metallo a gamba tubolare. Verniciatura in cataforesi e finitura per esterni.
Metal table with tubular leg. Cataphoresis paint and finish for outdoor.

Finiture standard
Standard finishes



Oggetto Item	Caratteristiche Tecniche (cm) Technical features (cm)			Prezzo Price	Imballo pz Packing pz	
	Altezza (h1) Height	Altezza (h2) Height	Diametro (d) Diameter		Finitura standard Standard Coating	Volume mc Volume mc
AUDREY	35	43	Ø 45			
			Ø 60			
			Ø 80			

** : inclusi piedini in gomma, protezioni su gambe e separatori in cartone.
including rubber feet, leg protectors and cardboard separators.

Ordine minimo
Minimum order



Pz

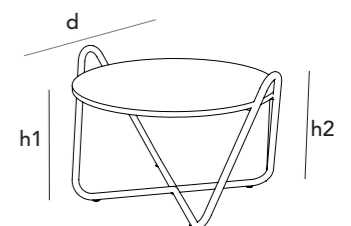

BRIGITTE

design: Lana+Savettiere Architetti

Tavolino
Coffee table



Tavolo in metallo a 4 gambe tubolari. Verniciatura in cataforesi e finitura per esterni.
Metal table with 4 tubular legs. Cataphoresis paint and finish for outdoor.

Finiture standard
Standard finishes



Oggetto Item	Caratteristiche Tecniche (cm) Technical features (cm)			Prezzo Price	Imballo pz Packing pz	
	Altezza (h) Height	Lato 1 Side 1	Lato 2 Side 2		Finitura standard Standard Coating	Volume mc Volume mc
BRIGITTE	35	70 70	70 110			

** : inclusi piedini in gomma, protezioni su gambe e separatori in cartone.
including rubber feet, leg protectors and cardboard separators.

Ordine minimo
Minimum order



Pz

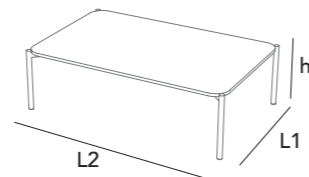

CORTINA

Tavolo
Table



Struttura in metallo per tavolo a 4 gambe quadrate.
Metal frame for table with 4 squared legs.

Finiture standard
Standard finishes



Oggetto Item	Caratteristiche Tecniche (cm) Technical features (cm)			Prezzo Price	Imballo pz Packing pz	
	Altezza (h1) Height	Lato 1 Side 1	Lato 2 Side 2		Finitura standard Standard Coating	Volume mc Volume mc
		70	70			
		80	80			
		90	90			
CORTINA	73,5	80	120			
		80	140			
		80	160			
		80	180			

** : inclusi tappi, puntali a fungo, protezioni su gambe e separatori in cartone.
including caps, push-in feet, leg guards and cardboard separators.

Ordine minimo
Minimum order



Pz

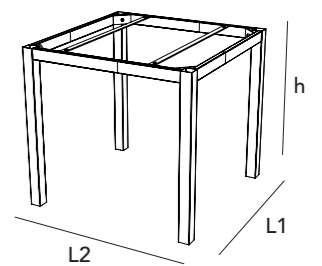

SEDUTE

SEATS

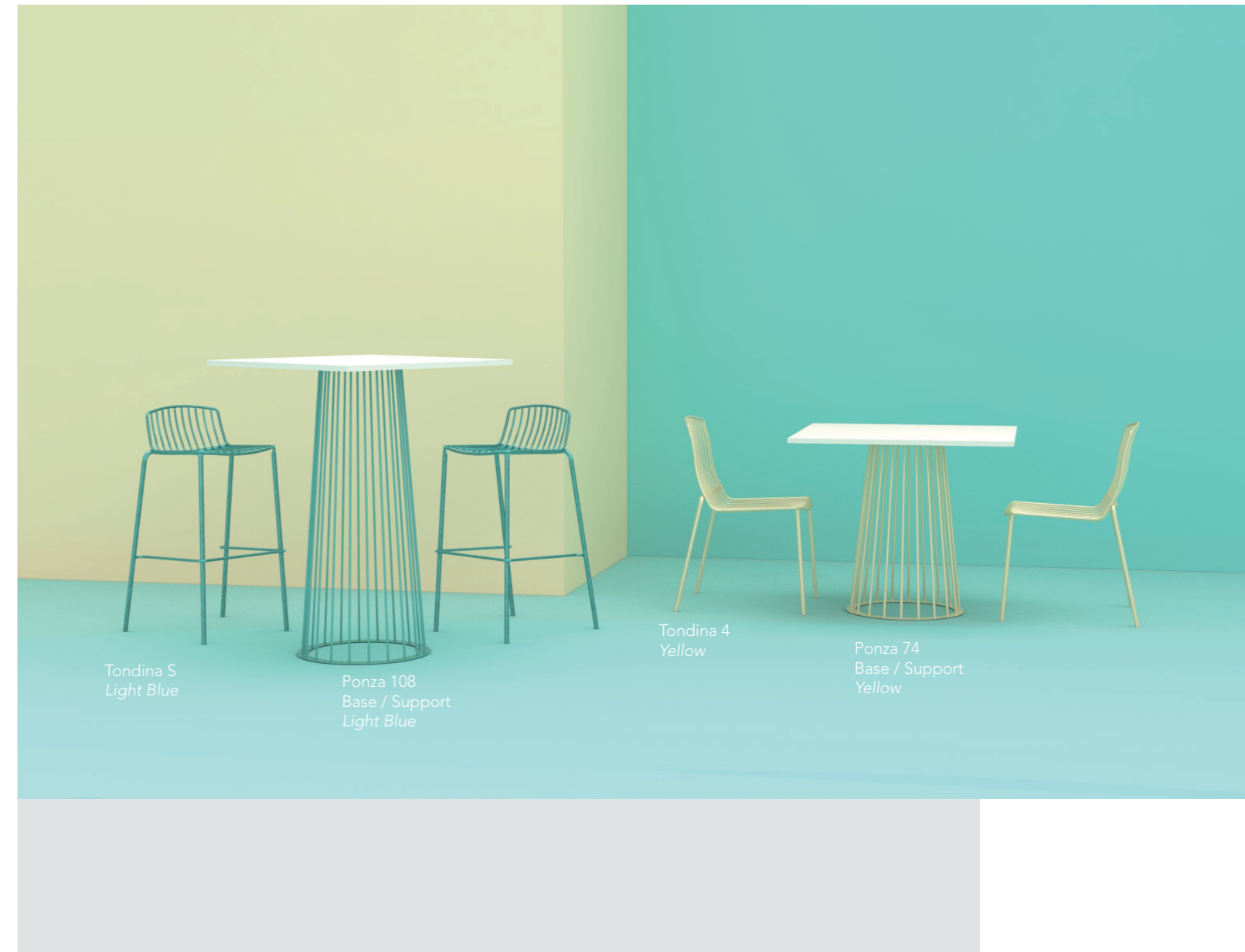

TONDINA



URBO consiglia l'abbinamento con
URBO suggests pairing with



Base Ponza h. 74
Ponza Support h. 74

Sedia in trafilato pieno 11 mm, verniciatura in cataforesi e finitura per esterni.
Chair in full drawn 11 mm, cathaphoresis painting and finish for outdoor.

Finiture standard
Standard finishes



Finiture metallo
Metal coatings



Oggetto Item	Caratteristiche Tecniche (cm) Technical features (cm)			Finitura standard Standard Coating	Finitura metal Metal Coating	Prezzo Price		Imballo pz Packing pz	
	Altezza (h) Height	Larghezza (a) Width	Profondità (b) Depth			Volume mc Volume mc	Peso kg Weight kg		
TONDINA	82	55	55						

Optional:
Cuscino per sedile lavabile e sfoderabile per esterni: 58,00 €
Washable and removable seat cushion for outdoor: 58,00 €

Cuscino per schienale lavabile e sfoderabile per esterni: 68,00 €
Washable and removable back cushion for outdoor: 68,00 €

Ordine minimo
Minimum order



Pz

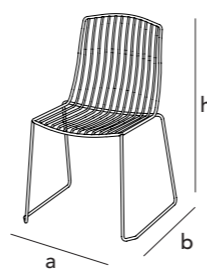

TONDINA 4



URBO consiglia l'abbinamento con
URBO suggests pairing with



Base Ponza h. 74
Ponza Support h. 74

Sedia, tubo d. 18, tondini da 11 e 8 mm, verniciatura in cataforesi e finitura per interni/esterni.
Chair, tube d. 18, 11 and 8 mm rods, cathaphoresis paint and finish for indoor/outdoor.

Finiture standard
Standard finishes



Finiture metallo
Metal coatings



Oggetto Item	Caratteristiche Tecniche (cm) Technical features (cm)			Finitura standard Standard Coating	Finitura metal Metal Coating	Prezzo Price		Imballo pz Packing pz	
	Altezza (h) Height	Larghezza (a) Width	Profondità (b) Depth			Volume mc Volume mc	Peso kg Weight kg		
TONDINA 4 Interni / Indoor	81	48	56						
TONDINA 4 Esterni / Outdoor	81	48	56						

Optional:
Cuscino per sedile lavabile e sfoderabile per esterni: 58,00 €
Washable and removable seat cushion for outdoor: 58,00 €

Cuscino per schienale lavabile e sfoderabile per esterni: 68,00 €
Washable and removable back cushion for outdoor: 68,00 €

Ordine minimo
Minimum order



Pz

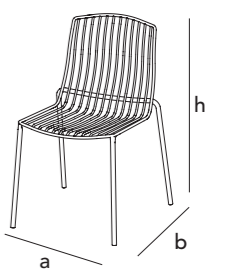

TONDINA B



Sedia con braccioli Chair with armrest

URBO consiglia l'abbinamento con
URBO suggests pairing with



Base Ponza h. 74
Ponza Support h. 74

Sedia con con braccioli, tubo d. 18, tondini da 11 e 8 mm, verniciatura in cataforesi e finitura per interni/esterni.
Chair with armrest, tube d. 18, 11 and 8 mm rods, cataphoresis paint and finish for indoor/outdoor.

Finiture standard
Standard finishes



Finiture metallo
Metal coatings

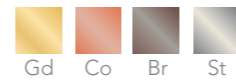

Oggetto Item	Caratteristiche Tecniche (cm) Technical features (cm)			Prezzo Price		Imballo pz Packing pz	
	Altezza (h) Height	Larghezza (a) Width	Profondità (b) Depth	Finitura standard Standard Coating	Finitura metal Metal Coating	Volume mc Volume mc	Peso kg Weight kg
TONDINA B Interni / Indoor	82	59	55				
TONDINA B Esterni / Outdoor	82	59	55				

Optional:
Cuscino per sedile lavabile e sfoderabile per esterni: 58,00 €
Washable and removable seat cushion for outdoor: 58,00 €
Cuscino per schienale lavabile e sfoderabile per esterni: 68,00 €
Washable and removable back cushion for outdoor: 68,00 €

Ordine minimo
Minimum order



Pz

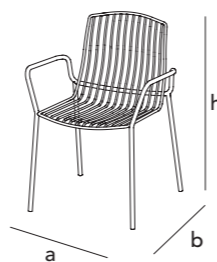

TONDINA S



H seduta/seat 62 cm

H seduta/seat 72 cm

Sgabello Stool

URBO consiglia l'abbinamento con
URBO suggests pairing with



Base Ponza h. 108
Ponza Support h. 108

Sgabello 4 gambe, d. 18, tondini da 11 e 8 mm, verniciatura in cataforesi e finitura per interni/esterni.
Stool 4 legs, tube d. 18, 11 and 8 mm rods, cataphoresis paint and finish for indoor/outdoor.

Finiture standard
Standard finishes



Finiture metallo
Metal coatings



Oggetto Item	Caratteristiche Tecniche (cm) Technical features (cm)			Prezzo Price		Imballo pz Packing pz	
	Altezza (h) Height	Larghezza (a) Width	Profondità (b) Depth	Finitura standard Standard Coating	Finitura metal Metal Coating	Volume mc Volume mc	Peso kg Weight kg
TONDINA S Interni / Indoor	80 / 65	49	47				
	90 / 75	49	49				
TONDINA S Esterni / Outdoor	80 / 65	49	47				
	90 / 75	49	49				

Optional:
Cuscino per sedile lavabile e sfoderabile per esterni: 58,00 €
Washable and removable seat cushion for outdoor: 58,00 €

Ordine minimo
Minimum order



Pz

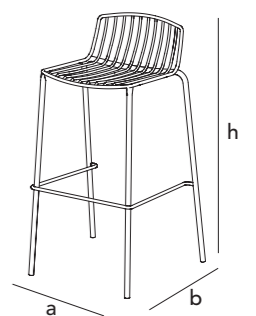

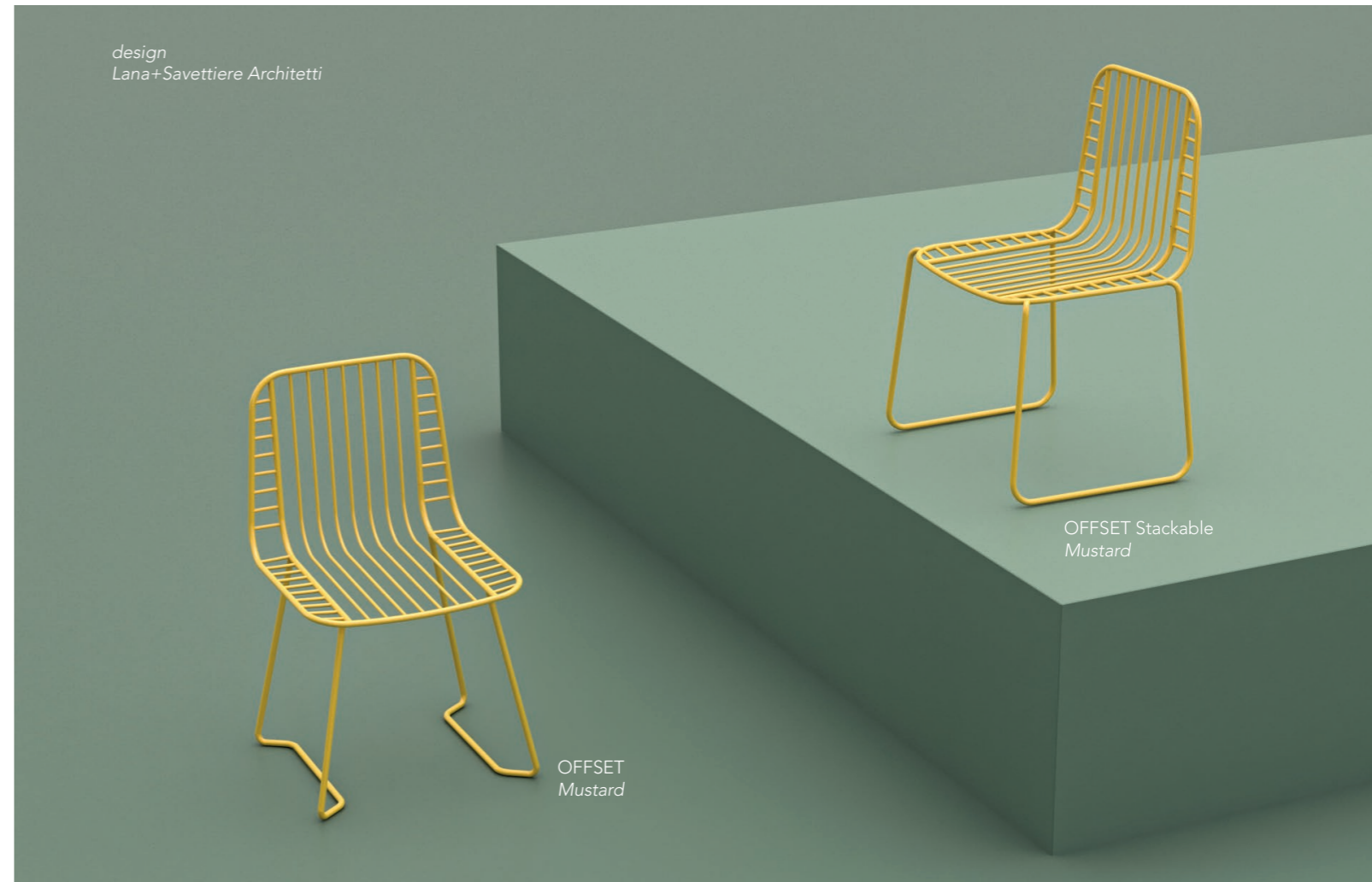
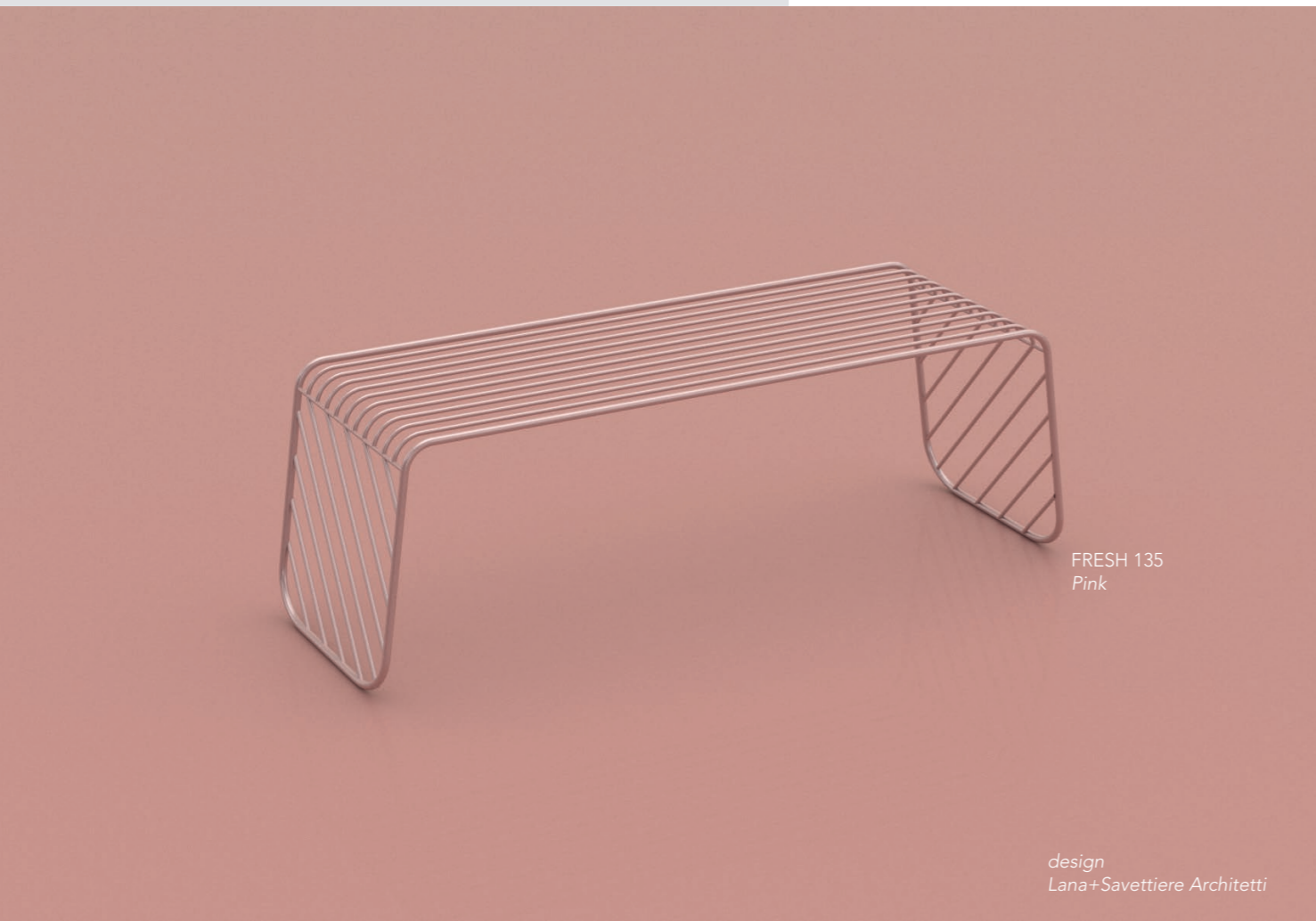

ALLY

design: Lana+Savettiere Architetti

Poltroncina
Armchair

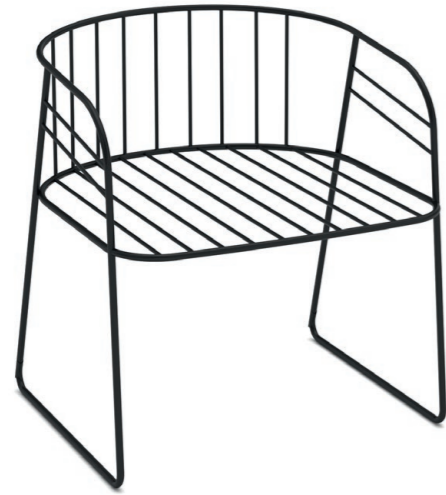

Poltroncina, tubo d. 14, tondini da 6 mm, verniciatura in cataforesi e finitura per esterni.
Armchair, d. 14 tube, 6 mm rods, cataphoresis paint and finish for outdoor.

Finiture standard
Standard finishes



Finiture metallo
Metal coatings



Oggetto Item	Caratteristiche Tecniche (cm) Technical features (cm)			Prezzo Price		Imballo pz Packing pz	
	Altezza (h) Height	Larghezza (a) Width	Profondità (b) Depth	Finitura standard Standard Coating	Finitura metal Metal Coating	Volume mc Volume mc	Peso kg Weight kg
ALLY	79	69	67				

Optional:
Cuscino per sedile lavabile e sfoderabile per esterni: 58,00 €
Washable and removable seat cushion for outdoor: 58,00 €

Ordine minimo
Minimum order

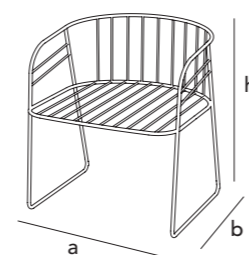
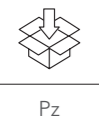

CHARLIE

design: Lana+Savettiere Architetti

Poltroncina
Armchair



Poltroncina, tubo d. 14, tondini da 6 mm, verniciatura in cataforesi e finitura esterni.
Armchair, d. 14 tube, 6 mm rods, cataphoresis paint and finish for outdoor.

Finiture standard
Standard finishes



Finiture metallo
Metal coatings



Oggetto Item	Caratteristiche Tecniche (cm) Technical features (cm)			Prezzo Price		Imballo pz Packing pz	
	Altezza (h) Height	Larghezza (a) Width	Profondità (b) Depth	Finitura standard Standard Coating	Finitura metal Metal Coating	Volume mc Volume mc	Peso kg Weight kg
CHARLIE	65	85	62				

Optional:
Cuscino per sedile lavabile e sfoderabile per esterni: 58,00 €
Washable and removable seat cushion for outdoor: 58,00 €
Cuscino per schienale lavabile e sfoderabile per esterni: 68,00 €
Washable and removable back cushion for outdoor: 68,00 €

Ordine minimo
Minimum order

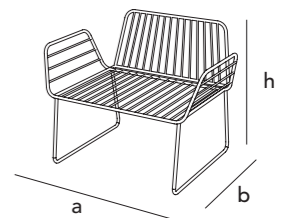
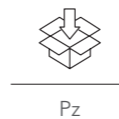

FRESH

design: Lana+Savettiere Architetti

Panca
Bench

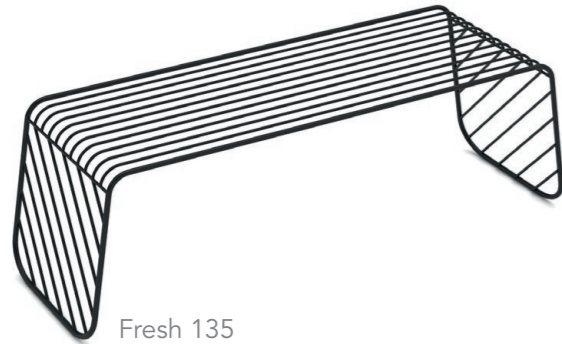
Fresh 135



Fresh 55

Panca e sgabello, tubo d. 14, tondini da 6 mm, verniciatura in cataforesi e finitura per esterni.
Bench and stool, d. 14 tube, 6 mm rods, cataphoresis paint and finish for outdoor.

Finiture standard
Standard finishes



Finiture metallo
Metal coatings



Oggetto Item	Caratteristiche Tecniche (cm) Technical features (cm)			Prezzo Price		Imballo pz Packing pz	
	Altezza (h) Height	Larghezza (a) Width	Profondità (b) Depth	Finitura standard Standard Coating	Finitura metal Metal Coating	Volume mc Volume mc	Peso kg Weight kg
FRESH 55	45	55	55				
FRESH 135	45	135	55				

Ordine minimo
Minimum order



Pz

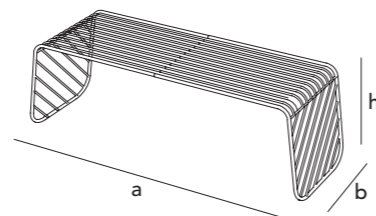

LEAF

design: Lana+Savettiere Architetti

Panca
Bench

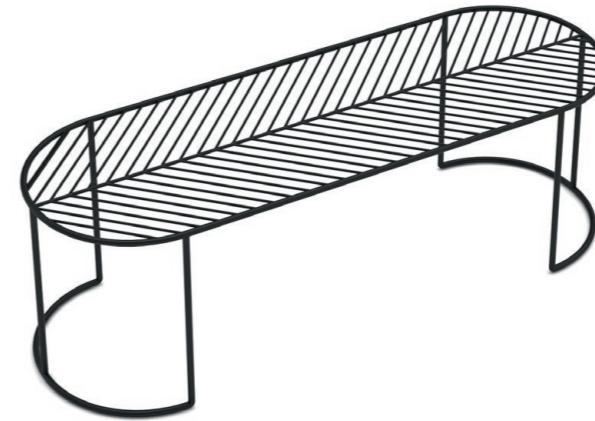
Panca, tubo d. 14, tondini da 6 mm, verniciatura in cataforesi e finitura per esterni.
Bench, d. 14 tube, 6 mm rods, cataphoresis paint and finish for outdoor.

Finiture standard
Standard finishes



Finiture metallo
Metal coatings



Oggetto Item	Caratteristiche Tecniche (cm) Technical features (cm)			Prezzo Price		Imballo pz Packing pz	
	Altezza (h) Height	Larghezza (a) Width	Profondità (b) Depth	Finitura standard Standard Coating	Finitura metal Metal Coating	Volume mc Volume mc	Peso kg Weight kg
LEAF	45	133	46				

Ordine minimo
Minimum order



Pz

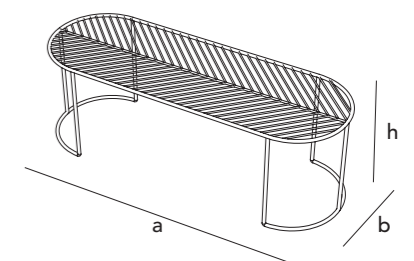

OFFSET

design: Lana+Savettiere Architetti

Sedia
Sedia



URBO consiglia l'abbinamento con
URBO suggests pairing with



Base Ponza h. 74
Ponza Support h. 74

Sedia, tubo d. 14, tondini da 6 mm, verniciatura in cataforesi e finitura per esterni.
Chair, d. 14 tube, 6 mm rods, cataphoresis paint and finish for outdoor.

Finiture standard
Standard finishes



Finiture metallo
Metal coatings



Oggetto Item	Caratteristiche Tecniche (cm) Technical features (cm)			Prezzo Price		Imballo pz Packing pz	
	Altezza (h) Height	Larghezza (a) Width	Profondità (b) Depth	Finitura standard Standard Coating	Finitura metal Metal Coating	Volume mc Volume mc	Peso kg Weight kg
OFFSET	86	51	50				

Optional:
Cuscino per sedile lavabile e sfoderabile per esterni: 58,00 €
Washable and removable seat cushion for outdoor: 58,00 €
Cuscino per schienale lavabile e sfoderabile per esterni: 68,00 €
Washable and removable back cushion for outdoor: 68,00 €

Ordine minimo
Minimum order



Pz

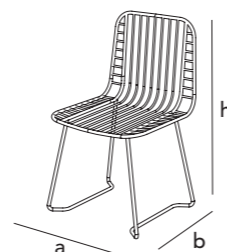

OFFSET Stackable

design: Lana+Savettiere Architetti

Sedia
Chair



URBO consiglia l'abbinamento con
URBO suggests pairing with



Base Ponza h. 74
Ponza Support h. 74

Sedia impilabile, tubo d. 14, tondini da 6 mm, verniciatura in cataforesi e finitura per esterni.
Stackable chair, d. 14 tube, 6 mm rods, cataphoresis paint and finish for outdoor.

Finiture standard
Standard finishes



Finiture metallo
Metal coatings



Oggetto Item	Caratteristiche Tecniche (cm) Technical features (cm)			Prezzo Price		Imballo pz Packing pz	
	Altezza (h) Height	Larghezza (a) Width	Profondità (b) Depth	Finitura standard Standard Coating	Finitura metal Metal Coating	Volume mc Volume mc	Peso kg Weight kg
OFFSET Stackable	86	60	51				

Optional:
Cuscino per sedile lavabile e sfoderabile per esterni: 58,00 €
Washable and removable seat cushion for outdoor: 58,00 €
Cuscino per schienale lavabile e sfoderabile per esterni: 68,00 €
Washable and removable back cushion for outdoor: 68,00 €

Ordine minimo
Minimum order



Pz

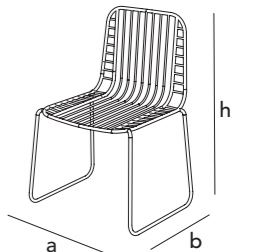

SWEET

design: Lana+Savettiere Architetti

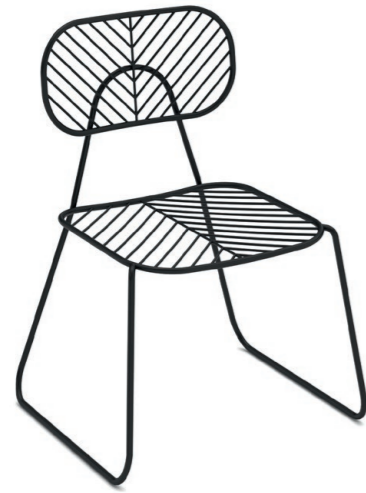

URBO consiglia l'abbinamento con
URBO suggests pairing with

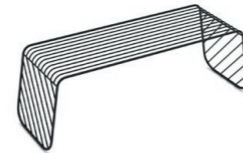

Panca FRESH
FRESH bench

Sedia impilabile, tubo d. 14, tondini da 6 mm, verniciatura in cataforesi e finitura per esterni.
Stackable chair, d. 14 tube, 6 mm rods, cataphoresis paint and finish for outdoor.

Finiture standard
Standard finishes



Finiture metallo
Metal coatings



Oggetto Item	Caratteristiche Tecniche (cm) Technical features (cm)			Prezzo Price	Imballo pz Packing pz		
	Altezza (h) Height	Larghezza (a) Width	Profondità (b) Depth		Finitura standard Standard Coating	Finitura metal Metal Coating	Volume mc Volume mc
SWEET	86	62	54				

Optional:
Cuscino per sedile lavabile e sfoderabile per esterni: 58,00 €
Washable and removable seat cushion for outdoor: 58,00 €

Ordine minimo
Minimum order



Pz



TWENTY

design: Lana+Savettiere Architetti



URBO consiglia l'abbinamento con
URBO suggests pairing with

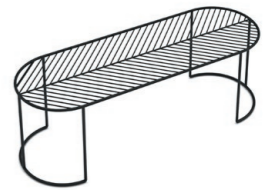

Panca LEAF
LEAF bench

Poltroncina con seduta in tessuto, tubo d. 14, tondini da 6 mm, verniciatura in cataforesi e finitura per esterni.
Armchair with fabric seat, d. 14 tube, 6 mm rods, cataphoresis paint and finish for outdoor.

Finiture standard
Standard finishes



Finiture metallo
Metal coatings



Oggetto Item	Caratteristiche Tecniche (cm) Technical features (cm)			Prezzo Price	Imballo pz Packing pz		
	Altezza (h) Height	Larghezza (a) Width	Profondità (b) Depth		Finitura standard Standard Coating	Finitura metal Metal Coating	Volume mc Volume mc
TWENTY	81	69	61				

Incluso / Included:
Cuscino per sedile lavabile e sfoderabile per esterni.
Washable and removable seat cushion for outdoor.

Ordine minimo
Minimum order



Pz

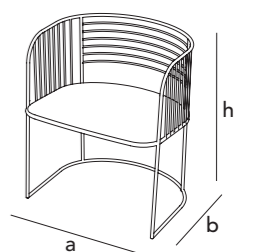

COLLEZIONI

COLLECTIONS



Collezione OLIVIA
OLIVIA collection
design
Alessandro Di Prisco

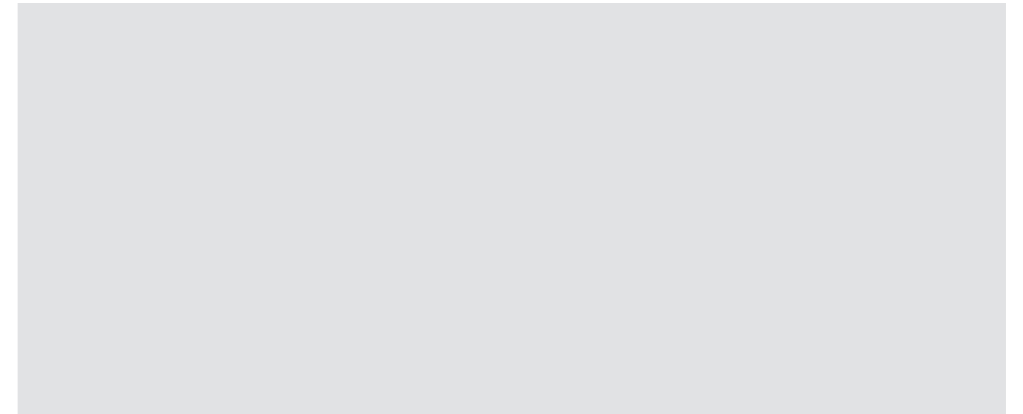

Collezione SOPHIE
SOPHIE collection
design
Lana+Savettiere Architetti

OLIVIA

design: Alessandro Di Prisco

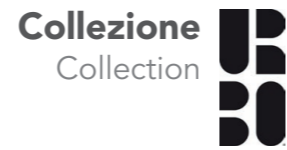

OLIVIA

design: Alessandro Di Prisco



Sedia sdraio con tavolino. Verniciatura in cataforesi e finiture per esterni.
Lounge seats with coffee table. Cataphoresis painting and finish for outdoor.

Finiture standard
Standard finishes

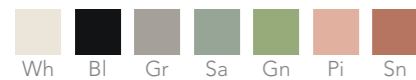

Finiture metallo
Metal coatings



Oggetto Item	Caratteristiche Tecniche (cm) Technical features (cm)			Prezzo Price	Imballo pz Packing pz		
	Altezza (h) Height	Larghezza (a) Width	Profondità (b) Depth		Finitura standard Standard Coating	Finitura metal Metal Coating	Volume mc Volume mc
Seduta lounge Lounge seat	74	64	69				
Tavolino Coffee table	31	54	56				



Collezione di sedute con cuscini. Verniciatura in cataforesi e finiture per esterni.
Seats collection with cushions. Cataphoresis painting and finish for outdoor.

Finiture standard
Standard finishes

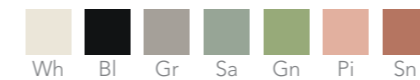

Finiture metallo
Metal coatings



Oggetto Item	Caratteristiche Tecniche (cm) Technical features (cm)			Prezzo Price	Imballo pz Packing pz		
	Altezza (h) Height	Larghezza (a) Width	Profondità (b) Depth		Finitura standard Standard Coating	Finitura metal Metal Coating	Volume mc Volume mc
Divano / Sofa	75	124	69				
Poltrona / Armchair	75	64	69				
Poltrona Bracciali Armchair armrest	75	64	69				

Ordine minimo
Minimum order



Pz

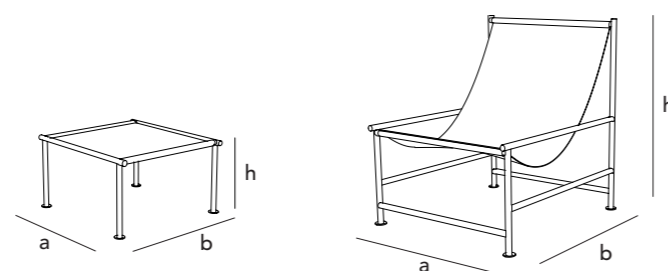

Ordine minimo
Minimum order



Pz

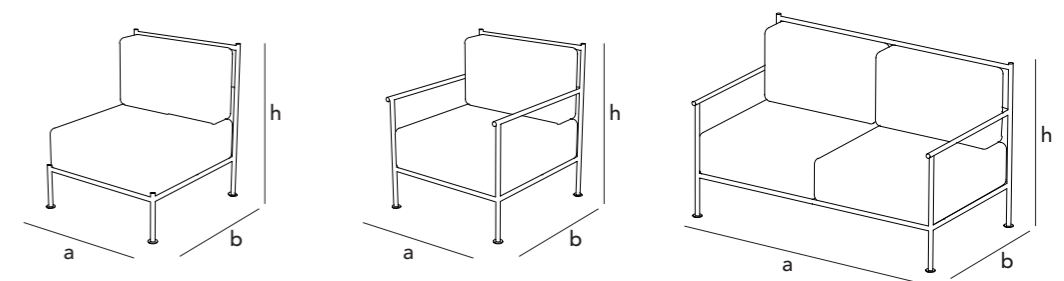

SOPHIE

design: Lana+Savettiere Architetti

Collezione
Collection



Collezione di sedute con cuscini e tavolino. Verniciatura in cataforesi e finiture per esterni.
Seats collection with cushions and coffee table. Cathaphoresis painting and finish for outdoor.

Finiture standard
Standard finishes



Finiture metallo
Metal coatings



Oggetto Item	Caratteristiche Tecniche (cm) Technical features (cm)			Prezzo Price	Imballo pz Packing pz		
	Altezza (h) Height	Larghezza (a) Width	Profondità (b) Depth	Finitura standard Standard Coating	Finitura metal Metal Coating	Volume mc Volume mc	Peso kg Weight kg
Poltrona / Armchair	68	90	82				
Divano / Sofa	68	160	82				
Tavolino / Coffee table	51	80	70				



Ordine minimo
Minimum order



Pz

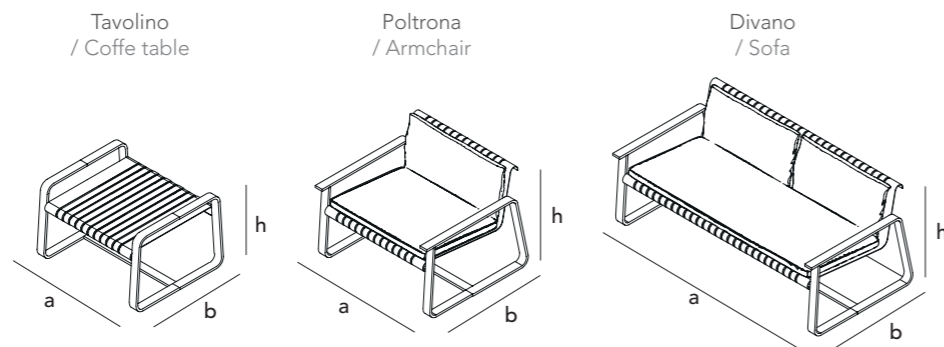



MOON small

design: Lana+Savettiere Architetti

Lampada
Light

Lampada
Light



Diam. 15 cm

Lampada LED da tavolo in tondino di acciaio.
Table LED lamp in steel rod.

Finiture standard
Standard finishes



Finiture metallo
Metal coatings



Oggetto Item	Caratteristiche Tecniche (cm) Technical features (cm)			Prezzo Price	Imballo pz Packing pz		
	Altezza (h) Height	Larghezza (a) Width	Profondità (b) Depth		Finitura standard Standard Coating	Finitura metal Metal Coating	Volume mc Volume mc
MOON small	18	17	10				

Ordine minimo
Minimum order



Pz

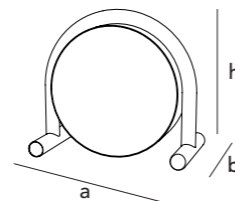

MOON medium

design: Lana+Savettiere Architetti

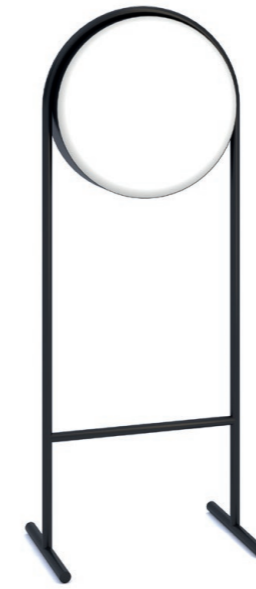

Diam. 30 cm

Lampada LED da terra in tondino di acciaio.
Floor LED lamp in steel rod.

Finiture standard
Standard finishes



Finiture metallo
Metal coatings



Oggetto Item	Caratteristiche Tecniche (cm) Technical features (cm)			Prezzo Price	Imballo pz Packing pz		
	Altezza (h) Height	Larghezza (a) Width	Profondità (b) Depth		Finitura standard Standard Coating	Finitura metal Metal Coating	Volume mc Volume mc
MOON medium	89,5	33	22				

Ordine minimo
Minimum order



Pz

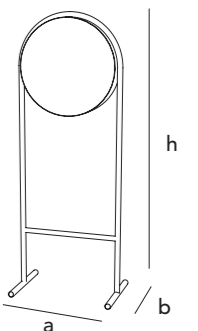

LUME

design: Lana+Savettiere Architetti

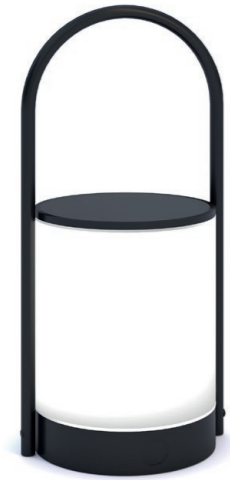

Lampada LED da tavolo in tondino di acciaio.
Table LED lamp in steel rod.

Finiture standard
Standard finishes



Finiture metallo
Metal coatings



Oggetto Item	Caratteristiche Tecniche (cm) Technical features (cm)			Prezzo Price		Imballo pz Packing pz	
	Altezza (h) Height	Larghezza (a) Width	Profondità (b) Depth	Finitura standard Standard Coating	Finitura metal Metal Coating	Volume mc Volume mc	Peso kg Weight kg
LUME	25	10	11				

MATERIALI E FINITURE

MATERIALS & FINISHES

Ordine minimo
Minimum order



Pz

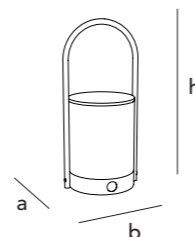

MATERIALI

Materials



ITALIAN KNOW HOW: UNA GARANZIA DI QUALITÀ

Da sempre Urbo è legata alla filosofia produttiva 100% Made in Italy e coerente con la cultura del proprio territorio, Urbo realizza e controlla tutte le fasi di produzione nel suo stabilimento.

Questo scrupoloso controllo, dai test durante le fasi di progettazione e lavorazione, ai processi di cataforesi e verniciatura, fino alla validazione del prodotto finito, assicura prodotti con un lungo ciclo di vita ed una massima resistenza all'utilizzo e agli agenti atmosferici.

ITALIAN KNOW-HOW: GUARANTEED QUALITY

Urbo has always been linked to the 100% Made in Italy production philosophy and consistent with the culture of its territory, Urbo realizes and controls all stages of production in its plant.

This scrupulous control, from tests during the design and manufacturing phases, to processes of cathaphoresis and painting up to the validation of the product finished, it ensures products with a long life cycle and maximum resistance to use and atmospheric agents.

NOTE

Note

Pesi, dimensioni e colori sono indicativi. Nella stampa su carta la tonalità dei colori non può essere riprodotta fedelmente. Urbo si riserva la facoltà di apportare modifiche in qualsiasi momento e senza preavviso.

Weights, measurements and colours are indicative. The colours cannot be reproduced exactly in print. Urbo reserves the right to make changes at any time and without prior notice.







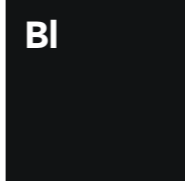

FINITURE

Finishes

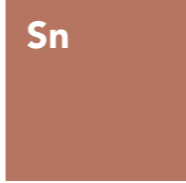

FINITURE STANDARD

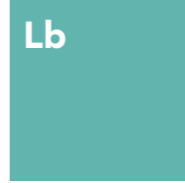
Standard finishes

 Wh	 Bl	 Gr	 Sa	 Gn	 Pi
Bianco White RAL 9010	Nero Black RAL 9005	Grigio Grey	Salvia Sage	Verde Green	Rosa Pink
 Sn	 Gd	 Lb	 Av	 Gn	 Mu
Siena Sienna	Terra Ground	Azzurro Light Blue	Avio Avio	Giallo Yellow	Mostarda Mustard

FINITURE STANDARD.

Standard finishes

 Gd	 Co	 Br	 St
Oro Gold	Rame Copper	Bronzo Bronze	Acciaio Steel

CONDIZIONI DI VENDITA

Sales terms



I prezzi sono espressi in Euro (IVA esclusa).
All prices are expressed in Euro (VAT excluded).

Resa della merce: Franco Fabbrica.
All mentioned prices are on Ex-works basis.

La merce viaggia a rischio e pericolo del committente.
Goods travel at customer's own risk.

Importo minimo di fatturazione: € 500,00 netti.
Minimum invoice amount: € 500,00 net.

Spese di imballo
Per ordini inferiori a 20 basamenti per tavoli addebito spese bancare € 20,00 netti.
Per ordini inferiori a € 500,00 netti accettati eccezionalmente, comunque non inferiori a € 250,00, addebito spese fisse per € 20,00 Netti.
Packaging costs
For orders with less than 20 table bases upcharge for the pallet of € 20,00 euro net. For orders lower than € 500,00 euro exceptionally accepted (anyway not lower than € 250,00), upcharge of € 20,00 euro net.

I tempi di consegna sono indicativi salvo nostra conferma esplicita. Eventuali ritardi non possono dar luogo a pretese di danni o annullamenti dell'ordine.
Delivery time is approximate, unless differently agreed. Possible delays can not justify any order cancellation or claim for damages.

La merce venduta con pagamento dilazionato è rilasciata con condizioni di riserva di proprietà fino a completo pagamento.
The goods sold through an extended payment are released under the condition with property reserve until full settlement.

Per ogni controversia è competente il foro di Vicenza , Italia (applicazione legge italiana).
For any dispute the place of jurisdiction will be the Court of Vicenza, Italy (under Italian law).

Eventuali reclami devono essere comunicati entro 8 giorni dal ricevimento della merce. In caso di sostituzione di merce o componenti. La resa è da intendersi EX-WORKS salvo diversi accordi tra le parti.
Any complaints shall be reported to Urbo within 8 days from receipt of the goods. In case of replacement for finished products or components, the freight costs are intended to be EX-WORKS, unless otherwise agreed between the parties.

Pesi, dimensioni e colori sono indicativi. Urbo si riserva la facoltà di apportare modifiche o migliorie senza alcun preavviso.
Weight, sizes and colours are approximate. Urbo reserves the right to modify or upgrade the product without prior notice.

In caso di spedizione via aerea (da comunicare in fase di conferma d'ordine) costi per pallettizzare i cartoni: € 200,00 netti per ordine.
Fixed costs whenever palletized cartons are required for air-freight shipments = € 200,00 net per order.

Supplemento Palett / plastica secondo regolamento FAO ISPM15 € 40,00 cad uno prezzo al pubblico.
Upcharge for plastic pallet (according to FAO ISPM15 regulation): € 40,00 each, public price.

I prezzi indicati sono espressi sul singolo prodotto, tutte le condizioni di vendita sono sottoposte ad accordi aziendali.
The prices indicated are expressed on the single product, all the conditions of sale are subject to company agreements.



M2U SRL
Via Bastion 49/4
Bassano Del Grappa (VI)
36061 - Italia
Phone +39 024573358

www.urbo.style